

stanton

C.400 USER MANUAL

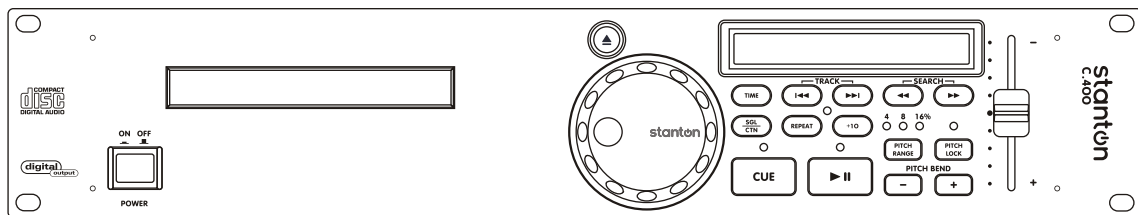

PROFESSIONAL SINGLE CD PLAYER

IMPORTANT TO SAFETY

WARNING:

- TO PREVENT FIRE OR SHOCK HAZARD, DO NOT USE THIS PLUG WITH AN EXTENSION CORD, RECEPTACLE OR OTHER OUTLET UNLESS THE BLADES CAN BE FULLY INSERTED TO PREVENT BLADE EXPOSURE.
- TO PREVENT FIRE OR SHOCK HAZARD. DO NOT EXPOSE THIS APPLIANCE TO RAIN OR MOISTURE.
- TO PREVENT ELECTRICAL SHOCK, MATCH WIDE BLADE PLUG TO WIDE SLOT FULLY INSERT.

CAUTION:

1. Handle the power supply cord carefully
Do not damage or deform the power supply cord. If it is damaged or deformed, it may cause electric shock or malfunction when used. When removing from wall outlet, be sure to remove by holding the plug attachment and not by pulling the cord.
2. In order to prevent electric shock, do not open the top cover. If a problem occurs, contact your dealer.
3. Do not place metal objects or spill liquid inside the CD player. Electric shock or malfunction may result.

Please, record and retain the Model name and serial number of your set shown on the rating label.

Model No. _____ Serial No. _____



CAUTION: TO REDUCE THE RISK OF ELECTRIC SHOCK, DO NOT REMOVE THE COVER (OR BACK) . NO USER-SERVICEABLE PARTS INSIDE.

REFER SERVICING TO QUALIFIED SERVICE PERSONNEL.



The lightning flash with arrowhead symbol, within an equilateral triangle, is intended to alert the user to the presence of un-insulated "dangerous voltage" within the product's enclosure that may be of sufficient magnitude to constitute a risk of electric shock to persons.



The exclamation point within an equilateral triangle is intended to alert the user to the presence of important operating and maintenance (servicing) instructions in the literature accompanying the appliance.

• FOR U.S.A. & CANADA MODEL ONLY

CAUTION

TO PREVENT ELECTRIC SHOCK DO NOT USE THIS (POLARIZED) PLUG WITH AN EXTENSION CORD, RECEPTACLE OR OTHER OUTLET UNLESS THE BLADES CAN BE FULLY INSERTED TO PREVENT BLADE EXPOSURE.

NOTE:

This CD player uses a semiconductor laser. To allow you to enjoy music at a stable operation, it is recommended to use this in a room of 5°C 41°F - 35°C 95°F.

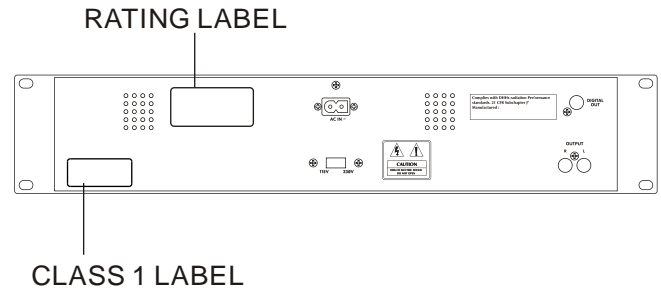

CAUTION:

USE OF CONTROLS OR ADJUSTMENTS OR REFORMATION OF PROCEDURES OTHER THAN THOSE SPECIFIED HEREIN MAY RESULT IN HAZARDOUS RADIATION EXPOSURE.

THE COMPACT DISC PLAYER SHOULD NOT BE ADJUSTED OR REPAIRED BY ANYONE EXCEPT PROPERLY QUALIFIED SERVICE PERSONNEL.

DOUBLE INSULATED - WHEN SERVICING, USE ONLY IDENTICAL REPLACEMENT PARTS.

NOTE:

This unit may cause interference to radio and television reception.

• Line Voltage Selection (for multiple voltage model only)

- ★ The desired voltage may be set with the VOLTAGE SELECTOR switch on the rear panel, using a screwdriver. 
- ★ Do not twist the VOLTAGE SELECTOR switch with excessive force as this may cause damage.
- ★ If the VOLTAGE SELECTOR switch does not move smoothly, please contact a qualified serviceman.

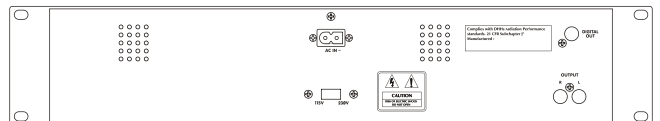

SAFETY INSTRUCTIONS

1. Read these Instructions
 2. Keep these Instructions
 3. Heed all Warnings
 4. Follow all Instructions
 5. Do not use this apparatus near water
 6. Clean only with dry cloth
 7. Do not block any ventilation openings. Install in accordance with the manufacturer's instructions.
 8. Do not install near any heat sources such as radiators, hear registers, stoves, or other apparatus (including amplifiers) that produce heat.
 9. Do not defeat the safety purpose of the polarized or grounding-type plug. A polarized plug has two blades with one wider than the other. A grounding type plug has two blades and a third grounding prong. The wide blade or the third prong are provided for your safety. If the provided plug does not fit into your outlet, consult an electrician for replacement of the obsolete outlet.
 10. Protect the power cord from being walked on or pinched particularly at plugs, convenience receptacles, and the point where they exit from the apparatus.
 11. Only use attachments/accessories specified by the manufacturer.
 12. Use only with the cart, stand, tripod, bracket, or table specified by the manufacturer, or sold with the apparatus. When a cart is used, use caution when moving the cart/apparatus combination to avoid injury from tip-over.
- 
13. Unplug this apparatus during lightning storms or when unused for long periods of time.
 14. Refer all servicing to qualified service personnel. Servicing is required when the apparatus has been damaged in any way, such as when the power-supply cord or plug is damaged, liquid has been spilled or objects have fallen into the apparatus, the apparatus has been exposed to rain or moisture, does not operate normally, or has been dropped.
 15. This appliance shall not be exposed to dripping or splashing water and that no object filled with liquids such as vases shall be placed on apparatus.

NOTE ON USE

- Allow for sufficient heat dispersion when installed in a rack.
- Handle the power cord carefully.
Hold the plug when unplugging the cord.
 - Keep the set free from moisture, water, and dust.
 - Unplug the power cord when not using the set for long periods of time.
 - Do not obstruct the ventilation holes. (For sets with ventilation holes.)
 - Do not place foreign objects in the set.
 - Do not let insecticides, benzene, and thinner come in contact with the set.
 - Never disassemble or modify the set in any way.
 - For 120 volt use in USA, USA nema style 120 volt plug. For other countries, use proper plug for the local outlet.

MAIN FEATURES

- (1) 8 times oversampling, 1 bit D/A converter.
- (2) 4 different scan speeds.
- (3) Frame search.
- (4) Auto cue.
- (5) Pitch display.
- (6) Digital output.

MAIN UNIT

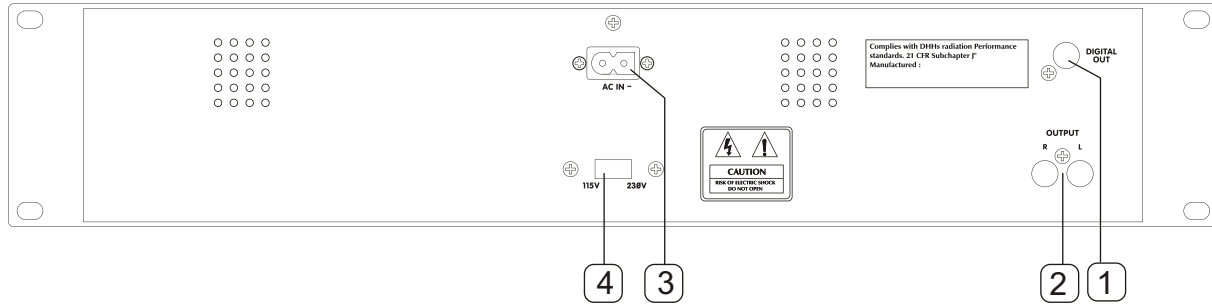

- (1) DIGITAL OUT SOCKET
- (2) AUDIO OUT L AND R
- (3) AC IN
- (4) VOLTAGE SELECTOR (Just For Dual Volatge Only)

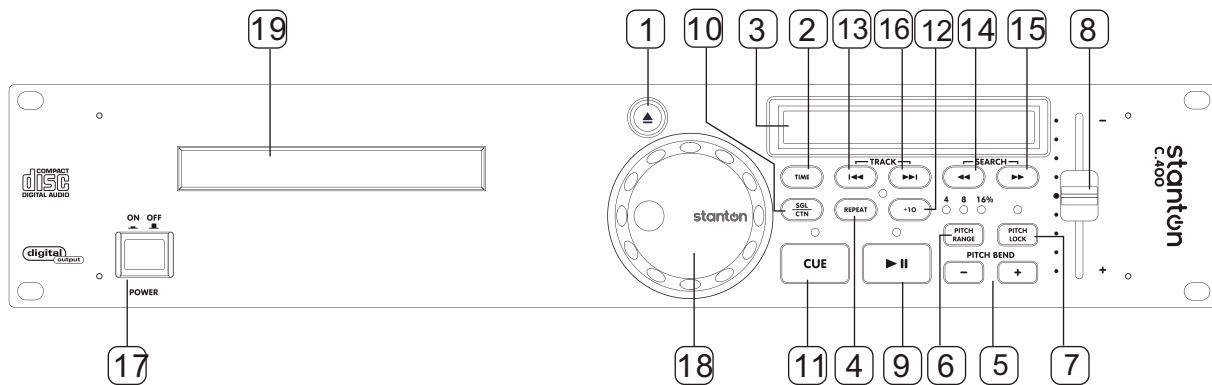

- (1) OPEN/CLOSE
- (2) TIME
- (3) LCD
- (4) REPEAT
- (5) PITCH +/-
- (6) PITCH RANGE
- (7) PITCH LOCK
- (8) PITCH SLIDER
- (9) PLAY/PAUSE
- (10) SGL/CTN
- (11) CUE
- (12) +10
- (13) TRACK
- (14) SEARCH
- (15) TRACK
- (16) POWER BUTTON
- (17) JOG
- (18) DISC HOLDER

MAIN FEATURES

LCD

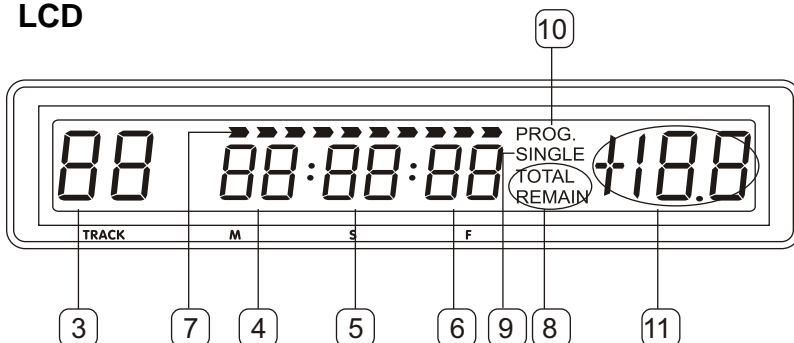

- (3)~(6) TRACK, MINUTE, SECOND and FRAME Displays
- (7) BAR Indicators
- (8) TOTAL/REMAIN Indicator
- (9) SINGLE Indicator
- (10) PROG Indicator
- (11) PITCH DISPLAY

PREPARATIONS

1. Checking the Contents

Check that the carton contains the following items:

- 1) Main unit
- 2) Pair of RCA cables
- 3) Operating instructions (this booklet)
- 4) Power cord

NAMES AND FUNCTIONS

Main Unit

(1) DIGITAL OUT SOCKET

Coaxial (S/P DIF) digital output for use with audio devices equipped with coaxial (S/P DIF) digital input such as digital mixing consoles and computer audio cards.

(3) AC IN

Plug in the power supply cable here.

(2) AUDIO OUT

The audio signals from each player are output from these jacks.

Main Unit

(1) OPEN/CLOSE

Press this button to open and close the disc holder. The main unit also includes OPEN/CLOSE buttons. The disc holder cannot be opened during playback, so stop playback before pressing the button.

(2) TIME (Time Button)

Press this button to switch the time display among the elapsed time and remaining time and total remaining time of the disc.

(3) LCD

(4) REPEAT

To place the unit into REPEAT mode press this button. Once the unit is in REPEAT mode the current track will play until the button is pressed again.

(5) PITCH +/- BUTTON

The CD speeds up while this button is pressed. Release the button to return to the original BPM. The CD slows down while this button is pressed. Release the button to return to the original BPM.

(6) PITCH RANGE

Choose from pitch percentages of 4%, 8% and 16%.

(7) PITCH LOCK

Use these buttons to enable or disable BPM adjustment with the pitch sliders. BPM adjustment with the pitch sliders is disabled when the PITCH LED lights.

(8) PITCH SLIDER

Use the slider to adjust the CD pitch. Slide up to decrease the pitch, down to increase the pitch.

(9) PLAY/PAUSE

Use this button to start playback. Press once to start playback, once again to set the pause mode, and once

more to resume playback.

(10) SGL/CTN (Single/Continuous Button)

Press this button to switch between single and continuous play modes. SINGLE mode is indicated by the SINGLE indicator on the LCD.

(11) CUE (Cue Button)

Press the CUE button during playback to return to the position at which playback started.

(12) +10

Use the button to skip ahead 10 tracks.

(13)

Use these buttons to go back to the beginning of the current track or select a previous track for playing.

(14),(15)

Press these buttons to perform the scan function during pause mode or during play mode.

(16)

Use these buttons to skip to the next CD track.

(17) POWER (Power ON/OFF Switch)

When the POWER switch is pressed, the power turns on.

(18) JOG (JOG dial)

When the dial is turned during CD pause, the point at which the sound is being produced moves by a number of frames corresponding to the number of clicks. Clockwise moves the point forward, counterclockwise moves the point backward.

(19) DISC HOLDER

Place the discs in the holder. Press the OPEN/CLOSE button to open and close the disc holder.

LCD

(3)~(6) Track, Minute, Second and Frame Displays

These displays indicate information for the CD's current position and time.

(7) BAR Indicator

These ten indicators provide a visual display of the approximate position of the pickup within the current track.

(8) TOTAL/REMAIN Indicator

When "TOTAL" and "REMAIN" are indicated in the LCD DISPLAY the TIME DESCRIBED in the LCD will define

the total disc remaining time.

(9) SINGLE Indicator

When SINGLE lights off, the CD player will play tracks continuously.

(10) PROG. Indicator

The PROG indicator lights when program mode is set.

(11) PITCH DISPLAY

This shows the BPM change range (the BPM changes within a range of +/-16%).

OPERATIONS

1. Opening and Closing the Disc Holder

- Turn the unit power on. Press the OPEN/CLOSE button to open the disc holder.
- The disc holder cannot be opened during playback to prevent playback from being interrupted if the OPEN/CLOSE button is pressed accidentally. Stop the playback first, then press the OPEN/CLOSE button.

2. Loading discs

- ❖ Hold the disc by the edges and place it in the disc holder, then press the OPEN/CLOSE button again to close the disc holder. The unit will show the total track number and the total playing time for about 2 seconds then enter the cue condition. The cue point will be set to the music starting point of the first track automatically.

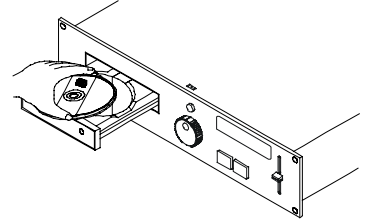

CAUTION:

- Do not place any foreign objects in the disc holder, and do not place more than one disc in the disc holder at a time.
- Do not push the disc holder in manually when the power is off, as this may result in malfunction and damages the player.

3. Selecting Tracks

- Press the TRACK button once to move to next higher or lower track.
- Hold the TRACK button to change tracks continuously at a higher speed.
- When a new track is selected during playback, playback begins as soon as the skip search operation is completed.
- If the TRACK **▶▶** button is pressed while at the last track, the first track is selected. In the same way, if the TRACK **◀◀** button is pressed while at the first track, the last track is selected.

4. Starting Playback

- Press the PLAY/PAUSE button during the pause or cue condition to start playback, the PLAY indicator lights.
- The point at which playback starts is automatically stored in the memory as the cue point. The pickup then returns to the cue point when the CUE button is pressed. (Back Cue)

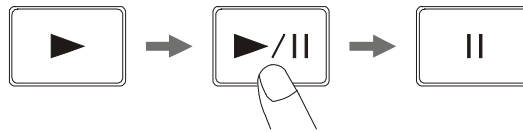

Figure 4-1

5A. Stopping Playback

There are two ways to stop playback.

1. Press the PLAY/PAUSE button during playback to pause at that point.
2. Press the CUE button during playback to return to the cue point and enter pause condition. (Back Cue)

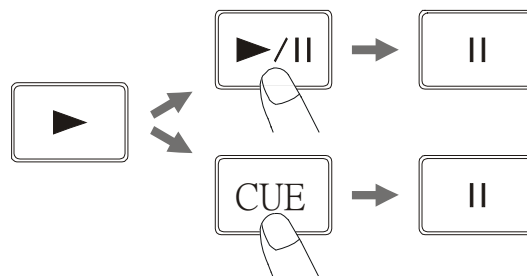

Figure 5-1

OPERATIONS

5B. Pausing

- Press the PLAY/PAUSE button to switch between play and pause.
- The play indicator flashes when the pause mode is set.
- Figure 5-2 shows the relationship between play and pause.

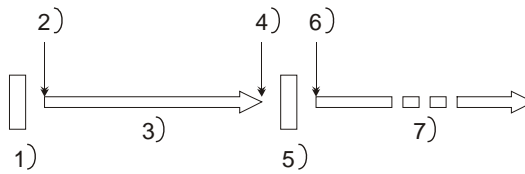

Figure 5-2

- 1) The player has completed the cue or pause operation and is waiting for the play start command.
- 2) PLAY/PAUSE button is pressed and player enters play mode.
- 3) Playing.
- 4) The PLAY/PAUSE button is pressed and the unit enters pause mode.
- 5) Pausing.
- 6) Playback resumes when the PLAY/PAUSE button is pressed again.
- 7) Playing.

6. Cueing

- "Cueing" is the process of preparing for playback.
- Press the CUE button, the player will enter cue mode. The playback returns to the cue point and the player enters the pause condition. The cue indicator lights up and the play indicator flashes. When the PLAY/PAUSE button is pressed, playback starts from the cue point.
- When the track search operation is completed after pressing the SKIP buttons, the player automatically finds the position at which the sound starts and cues there (Auto Cue).
- If the CUE button is pressed after the search operation or the scanning operation, playback returns to the cue point and enter pause condition.
- Figure 6-1 shows the relationship between the play and back cue operations.

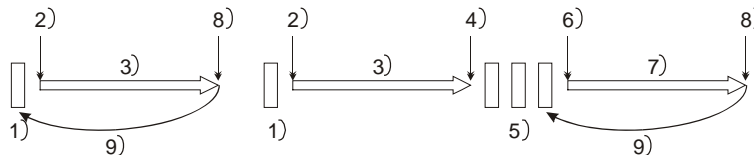

Figure 6-1

- 1) The player has completed the cue or pause operation and is waiting for the play start command.
- 2) When the PLAY/PAUSE button is pressed, playback starts and the cue point is stored in the memory.
- 3) Playing.
- 4) The pause mode is set when the PLAY/PAUSE button is pressed again.
- 5) Pausing.
- 6) The PLAY/PAUSE button is pressed again;
- 7) Playing.
- 8) Press the CUE button.
- 9) The pickup returns to the cue point. (Back Cue)

❖ Cue point setting:
When play starts from pause by pressing the IN button or by using Scanning or Frame Search, or if you skip to a new track by using the skip button, the begin play point will be set to the new cue point.

When a new cue point is set, the cue indicator lights by flashing for about 1 second.

NOTE: During cue mode, if the CUE button is pressed and held, playback will start from the cue point. When the button is released, the player will return to the cue mode automatically. This allows you to check the cue point.

7. Jog Wheel - The jog wheel serves two functions depending on the current operating mode:

- The jog wheel will act as a slow frame search control when the unit is in pause or cue mode allowing you to set a specific cue point or find a particular starting point.
- The wheel also works as a momentary pitch bend during playback. Turning the wheel clockwise will increase the pitch percentage up to 4%, 8%, 16%, and turning the wheel in the counterclockwise direction will decrease the pitch percentage up to -16%. The pitch bend will be determined on how fast you turn the wheel.

OPERATIONS

8. Scanning (Fast forward/Fast backward)

- Scanning is a function for moving quickly forward or backward in the track when the ◀◀ or ▶▶ button is pressed.
- The scanning speed depends on how long you hold the button.
- Press and hold the ◀◀ or ▶▶ to begin scanning. The disc moves rapidly forward or backward and the sound is played. The current scan point is indicated on the LCD.
- Press and hold the ▶▶ to scan in the forward scanning, ◀◀ to scan in the reverse scanning.

9. Time display

Press the TIME button to select the time display mode:

- ① Elapsed time of a track.
- ② Remaining time of a track.
- ③ Total remaining time of the disc.

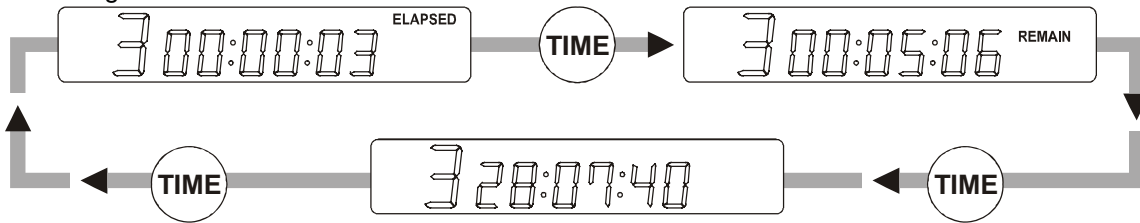

Total remaining time of the disc

Figure 9-1

10. Matching the Beats Per Minute (BPM)

There are three tools available for matching the BPM of the two CDs:

- ① Use the pitch slider to adjust the BPM statically.
- ② Use the PITCH BEND buttons to change the BPM temporarily.
- ③ Use the JOG WHEEL to change the BPM temporarily.

1) Pitch Slider

- To adjust the BPM by sliding the pitch slider up or down, you must first press the PITCH button to turn on the PITCH.
- Slide the pitch slider up to decrease BPM, or down to increase BPM. The adjustment range is switchable from +/- 4%, +/- 8% to +/- 16%.

2) Pitch Bending

- The BPM increases or decreases respectively while the PITCH BEND+ or PITCH BEND- button is pressed.
- The BPM increase depends on how long you hold the button. If you hold the button for about 1/2 second, the BPM will go either to +16% for PITCH BEND+ or -16% for PITCH BEND-. If you tap the button, the BPM will only change a little so you can change the beat slightly without audible changes in the music.
- The CD will return to the tempo indicated by the Pitch slider when you let go of the PITCH BEND+ or -.

BEFORE SWITCHING OFF THE POWER

CAUTION:

Do not forcibly close the disc holder when the power is off.

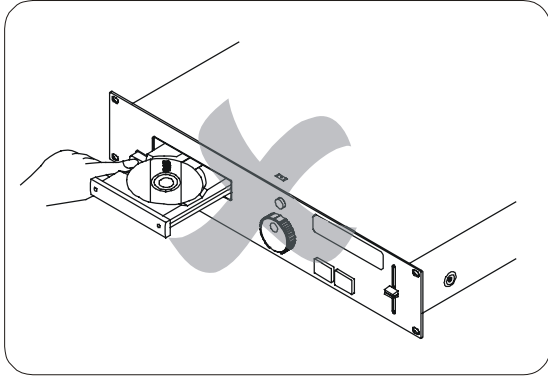

Do not switch off the power when the disc holder is open.

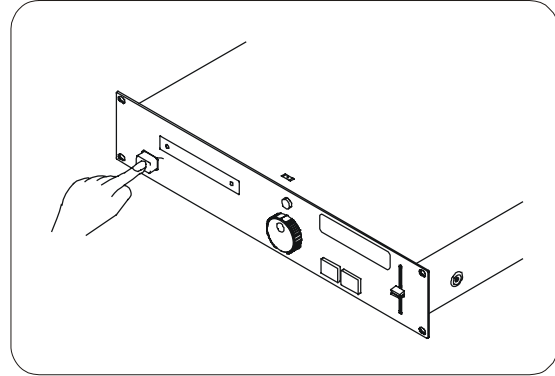

To avoid damage, please don't switch the power until the disc holder has been closed with the OPEN/CLOSE button and the LCD displays "no disc" or "time code" shows.

COMPACT DISCS

1. Precautions on handling compact discs

- Do not allow fingerprints, oil or dust to get on the surface of the disc.

If the disc is dirty, wipe it off with a soft dry cloth.

- Do not use benzene, thinner, water, record spray, electrostatic-proof chemicals, or silicone-treated cloths to clean discs.
- Always handle discs carefully to prevent damaging the surface; in particular when removing a disc from its case or returning it.
- Do not bend the disc.
- Do not apply heat.
- Do not enlarge the hole in the center of the disc.

- Do not write on the label (printed side) with a hard-tipped implement such as a pencil or ball point pen.
- Condensation will form if a disc is brought into a warm area from a colder one, such as outdoors in winter. Do not attempt to dry the disc with a hair dryer, etc.

2. Precaution on storage

- After playing a disc, always unload it from the player.
- Always store the disc in the jewel case protect from dirt or damage.
- Do not place discs in the following areas:
 - ① Areas exposed to direct sunlight for a considerable time.
 - ② Areas subject to accumulation of dust or high humidity.
 - ③ Areas affected by heat from indoor heaters, etc.

SPECIFICATIONS

GENERAL

Dimensions:	482(W) x 88.8(H) x 266(D) mm 19"(W) x 3 1/2"(H) x 10 1/2"(D)
Weight:	4.5 kgs / 9.91 lbs
Power supply:	Dual Voltage: AC 115/230V, 50/60Hz Single Voltage: AC 100V, 50/60Hz (For Japan) AC 110V, 60Hz (For Taiwan) AC 120V, 60Hz (For U.S.A.,Canada,Mexico) AC 220V, 50Hz (For United Arab Emirates,Chile,Aegentina) AC 220V, 60Hz (For Philippines) AC 230V, 50Hz (For Europe,New Zealand,South Africa,Singapore,Israel) AC 240V, 50Hz (For Australia,U.K)
Power consumption:	13W

Stanton Magnetics, Inc. – Warranty Provision – Returns for Repairs or Replacement

WARRANTY

Through Stanton's authorized dealers around the World, Stanton, or one of Stanton's authorized distributors outside the U.S., will, without charge, repair or replace, at the sole discretion of the entity responsible for making the repair or providing the replacement, any Stanton merchandise proved defective in material or workmanship for a period of one (1) year following the date of original purchase. Exceptions to this warranty are as noted below:

The warranty for mechanical parts which are subject to wear and tear are limited to the earlier to occur of thirty (30) days following the date of original purchase or the following number of cycles: Faders - 15,000; Rotary potentiometers - 10,000; and Switches - 10,000.

Stanton will warrant all replacement parts and repairs for ninety (90) days from the date of original shipment. Repairs made necessary by reason of misuse, alteration, normal wear, or accident are not covered under this warranty.

RETURNS

Authorized Stanton dealers are only authorized to sell and distribute merchandise within a specific country. All goods requiring warranty repair or replacement must be returned (freight prepaid if not hand-delivered) to the authorized Stanton dealer from whom the merchandise was purchased and in the same country where the merchandise was purchased. For purposes of purchases made via the Internet, the merchandise must be returned to the authorized Stanton dealer in the country where the authorized Stanton dealer which sold the merchandise to purchaser is located and not the authorized Stanton dealer in the country where the purchaser is located or the country in which the merchandise was received. Any returns to a non-authorized dealer or to an authorized Stanton dealer not in the same country as the merchandise was intended to be sold or as set forth above will void this warranty.

To initiate a warranty repair, you must contact the authorized Stanton dealer from whom you purchased the merchandise, and follow such authorized Stanton dealer's return policy.

Stanton assumes no risk and shall be subject to no liability for damages or loss resulting from the specific use or application made of the merchandise. Stanton's liability for any claim, whether based on breach of contract, negligence, infringement of any rights of any party, or product liability, and relating to the merchandise shall not exceed the price received by Stanton from your purchase of such merchandise. In no event will Stanton be liable for any special, incidental or consequential damages (including loss of use, loss of profit and claims of third parties) however caused, whether by the negligence of Stanton or otherwise. To the extent permitted by law and except as otherwise provided above, Stanton disclaims any express or implied warranties of merchantability or fitness for a particular purpose.

The above warranty provides you with specific legal rights. You may also have additional rights, which are subject to variation from state to state and country to country.

If there is a dispute regarding the warranty of merchandise that does not fall under the warranty conditions stated above, please include a written explanation with the merchandise when returned pursuant to the terms and conditions set forth herein.

Please register your product online at www.stantondj.com or mail your completed warranty card to:

Stanton Magnetics, Inc, 3000 SW 42 St. Hollywood, Florida 33312.