

STANTON

S-500 USER MANUAL

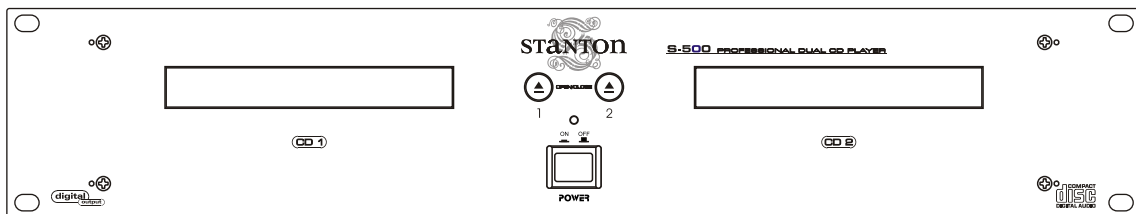
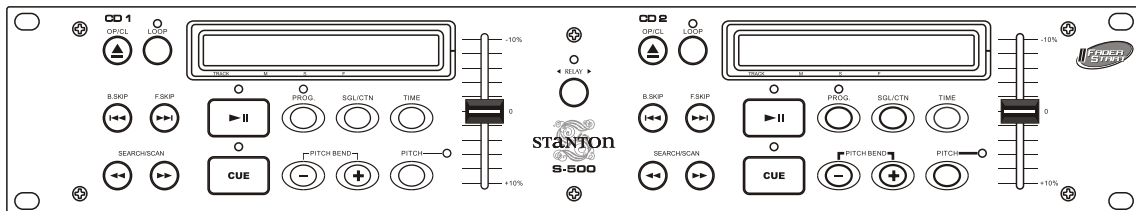

PROFESSIONAL DUAL CD PLAYER

IMPORTANT TO SAFETY

IMPORTANT TO SAFETY

WARNING:
TO PREVENT FIRE OR SHOCK HAZARD, DO NOT EXPOSE THIS APPLIANCE TO RAIN OR MOISTURE.

CAUTION:

1. Handle the power supply cord carefully
Do not damage or deform the power supply cord. If it is damaged or deformed, it may cause electric shock or malfunction when used. When removing from wall outlet, be sure to remove by holding the plug attachment and not by pulling the cord.
2. In order to prevent electric shock, do not open the top cover. If a problem occurs, contact your dealer.
3. Do not place metal objects or spill liquid inside the CD player. Electric shock or malfunction may result.

Please, record and retain the Model name and serial number of your set shown on the rating label.

Model No. _____ Serial No. _____



CAUTION: TO REDUCE THE RISK OF ELECTRIC SHOCK, DO NOT REMOVE THE COVER (OR BACK) . THERE ARE NO SERVICEABLE PARTS INSIDE.

REFER SERVICING TO QUALIFIED SERVICE PERSONNEL.



The lightning flash with arrowhead symbol, within an equilateral triangle, is intended to alert the user to the presence of uninsulated "dangerous voltage" within the product's enclosure that may be of sufficient magnitude to constitute a risk of electric shock to persons.



The exclamation point within an equilateral triangle is intended to alert the user to the presence of important operating and maintenance (servicing) instructions in the literature accompanying the appliance.

• FOR U.S.A. & CANADA MODEL ONLY

CAUTION

TO PREVENT ELECTRIC SHOCK DO NOT USE THIS (POLARIZED) PLUG WITH AN EXTENSION CORD, RECEPTACLE OR OTHER OUTLET UNLESS THE BLADES CAN BE FULLY INSERTED TO PREVENT BLADE EXPOSURE.

NOTE:

This CD player uses the semiconductor laser. To allow you to enjoy music at a stable operation, it is recommended to use this in a room of 5°C 41°F - 35°C 95°F.

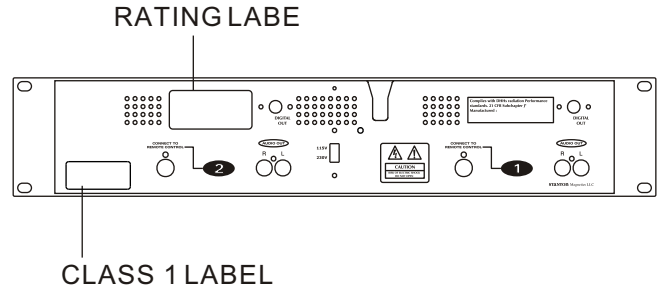

CAUTION:

USE OF CONTROLS OR ADJUSTMENTS OR REFORMANCE OF PROCEDURES OTHER THAN THOSE SPECIFIED HEREIN MAY RESULT IN HAZARDOUS RADIATION EXPOSURE.

THE COMPACT DISC PLAYER SHOULD NOT BE ADJUSTED OR REPAIRED BY ANYONE EXCEPT PROPERLY QUALIFIED SERVICE PERSONNEL.

DOUBLE INSULATED - WHEN SERVICING, USE ONLY IDENTICAL REPLACEMENT PARTS.

NOTE:

This unit may cause interference to radio and television reception.

• Line Voltage Selection (for multiple voltage model only)

- ★ The desired voltage may be set with the 115V VOLTAGE SELECTOR switch on the rear panel, using a screwdriver.
- ★ Do not twist the VOLTAGE SELECTOR 230V switch with excessive force as this may cause damage.
- ★ If the VOLTAGE SELECTOR switch does not move smoothly, please contact a qualified serviceman.

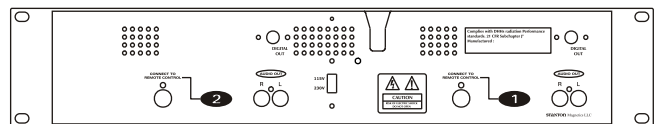

SAFETY INSTRUCTIONS

1. Read Instructions – All the safety and operating instructions should be read before the appliance is operated.
2. Retain Instructions – The safety and operating instructions should be retained for future reference.
3. Heed Warnings – All warnings on the appliance and in the operating instructions should be adhered to.
4. Follow Instructions – All operating and use instructions should be followed.
5. Water and Moisture – The appliance should not be used near water - for example, near a bathtub, washbowl, kitchen sink, laundry tub, in a wet basement, or near a swimming pool, and the like.
6. Carts and Stands – The appliance should be used only with a cart or stand that is recommended by the manufacturer.
- 6A. An appliance and cart combination should be moved with care. Quick stops, excessive force, and uneven surfaces may cause the appliance and cart combination to overturn. 
7. Wall or Ceiling Mounting – The appliance should be mounted to a wall or ceiling only as recommended by the manufacturer.
8. Ventilation – The appliance should be situated so that its location or position does not interfere with its proper ventilation. For example, the appliance should not be situated on a bed, sofa, rug, or similar surface that may block the ventilation openings; or, placed in a built-in installation, such as a bookcase or cabinet that may impede the flow of air through the ventilation openings.
9. Heat – The appliance should be situated away from heat sources such as radiators, heat registers, stoves, or other appliances (including amplifiers) that produce heat.
10. Power Sources – The appliance should be connected to a power supply only of the type described in the operating instructions or as marked on the appliance.
11. Grounding or Polarization – Precautions should be taken so that the grounding or polarization means of an appliance is not defeated.
12. Power-Cord Protection – Power-supply cords should be routed so that they are not likely to be walked on or pinched by items placed upon or against them, paying particular attention to the cord in correspondence of plugs, convenience receptacles, and the point where they exit from the appliance.
13. Cleaning - The appliance should be cleaned only as recommended by the manufacturer. Clean by wiping with a cloth slightly damp with water. Avoid getting water inside the appliance.
14. Disconnect power cord before servicing.
15. Replace critical components  only with factory parts or recommended equivalents.
16. For AC line powered units - Before returning repaired unit to user, use an ohm-meter to measure from both AC plug blades to all exposed metallic parts. The resistance should be more than 100,000 ohms.
17. Non-use Periods – The power cord of the appliance should be unplugged from the outlet when left unused for a long period of time.
18. Object and Liquid Entry – Care should be taken so that objects do not fall and liquids are not spilled into the enclosure through openings.
19. Damage Requiring Service – The appliance should be serviced by qualified service personnel when:
 - A. The power-supply cord or the plug has been damaged; or
 - B. Objects have fallen, or liquid has been spilled into the appliance; or
 - C. The appliance has been exposed to rain; or
 - D. The appliance does not appear to operate normally or exhibits a marked change in performance; or
 - E. The appliance has been dropped, or the enclosure damaged.
20. Servicing – The user should not attempt any service to the appliance beyond that described in the operating instructions. All other servicing should be referred to qualified service personnel.
21. Ventilation – The appliance should be situated so that its location or position does not interfere with its proper ventilation. For example, the appliance should not be situated on a bed, sofa, rug, or similar surface that may block the ventilation openings; or, placed in a built-in installation, such as a bookcase or cabinet that may impede the flow of air through the ventilation openings.
22. Cleaning – The appliance should be cleaned only as recommended by the manufacturer.
23. Nonuse Periods – The power cord of the appliance should be unplugged from the outlet when left unused for a long period of time.

NOTE ON USE

Allow for sufficient heat dispersion when installed on a rack.

- Handle the power cord carefully.
Hold the plug when unplugging the cord.
- Keep the set free from moisture, water, and dust.
- Unplug the power cord when not using the set for long periods of time.
- Do not obstruct the ventilation holes. (For sets with ventilation holes.)
- Do not let foreign objects in the set.
- Do not let insecticides, benzene, and thinner come in contact with the set.
- Never disassemble or modify the set in any way.
- For 220 volt use in USA, USA nema style 220 volt plug. For other countries, use proper plug for the local outlet.

MAIN FEATURES

- (1) 8 times oversampling 1 bit D/A converter.
- (2) 3 different speed scan.
- (3) Frame search.
- (4) Auto cue.
- (5) 20 tracks program play.
- (6) Pitch display.

MAIN UNIT

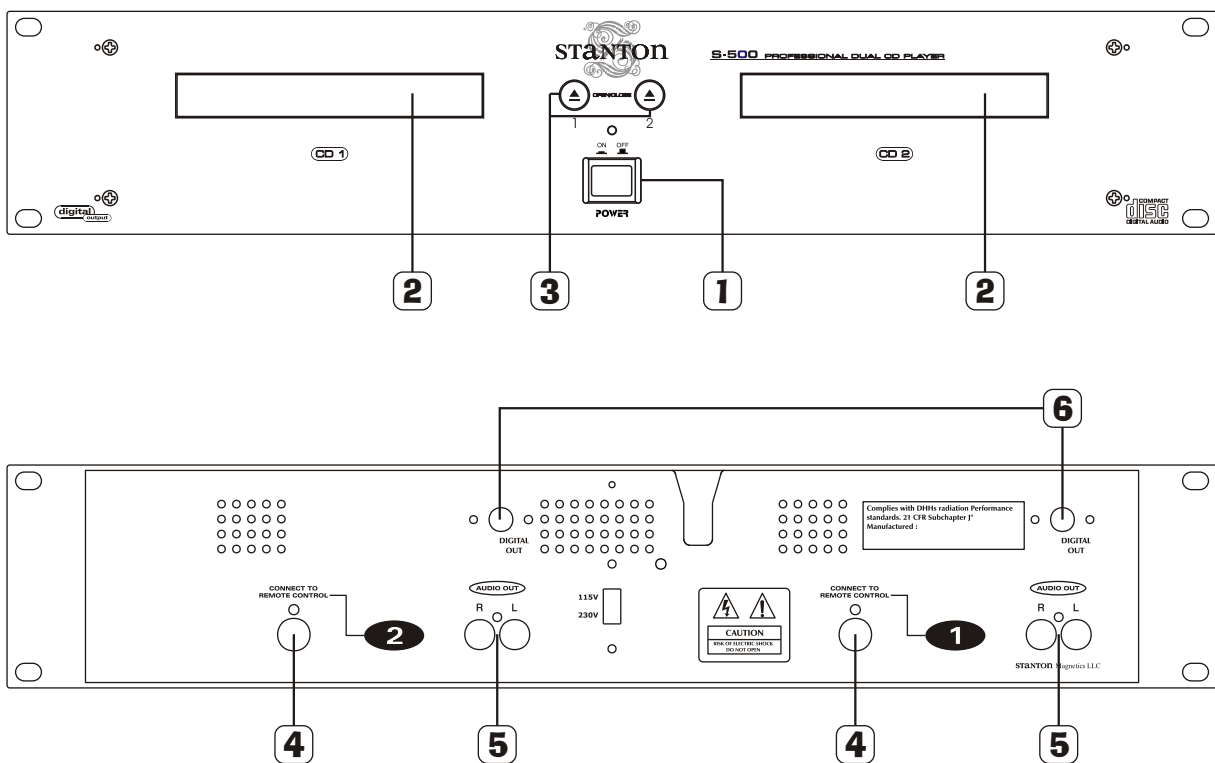

- (1) POWER
- (2) Disc Holder
- (3) OP/CL
- (4) REMOTE CONTROL CONNECTOR
- (5) AUDIO OUT
- (6) DIGITAL OUT SOCKET

MAIN FEATURES

CONTROL UNIT

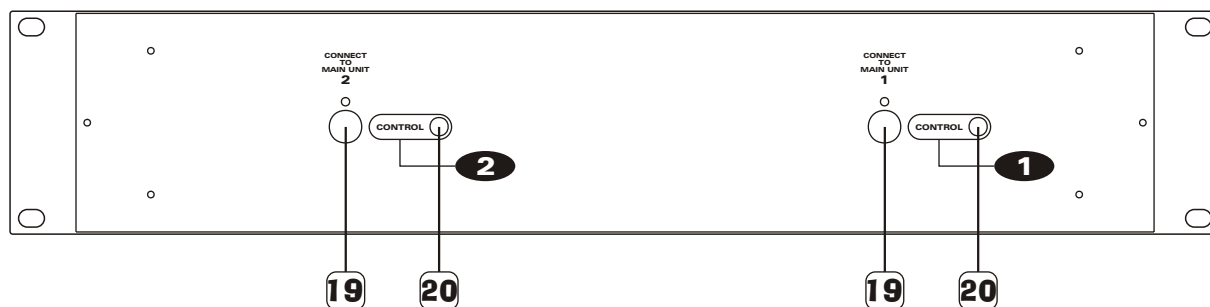
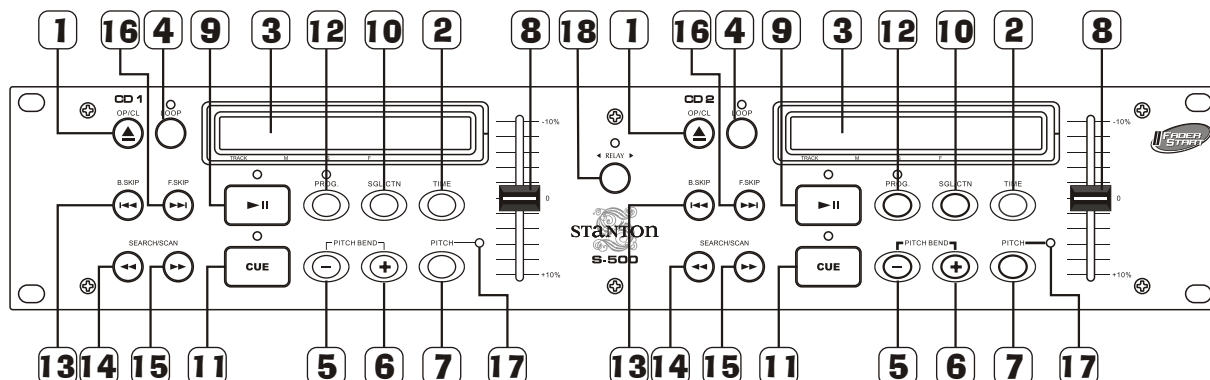

- | | |
|-----------------------------------------|------------------------------|
| (1) OP/CL | (11) CUE (Cue Button) |
| (2) TIME (Time Button) | (12) PROG. |
| (3) LCD (Liquid Crystal Display) | (13) B.SKIP ◀◀ |
| (4) LOOP (Loop button) | (14) SEARCH/SCAN ◀◀ |
| (5) PITCH - (Pitch Bend - Button) | (15) SEARCH/SCAN ▶▶ |
| (6) PITCH +(Pitch Bend + Button) | (16) F.SKIP ▶▶▶ |
| (7) PITCH (Pitch Button) | (17) PITCH (Pitch Indicator) |
| (8) Pitch Slider | (18) RELAY |
| (9) PLAY/PAUSE ▶/ (Play/Pause Button) | (19) CONTROL CONNECTOR |
| (10) SGL/CTN (Single/Continuous Button) | (20) CONTROL SOCKETS |

LCD

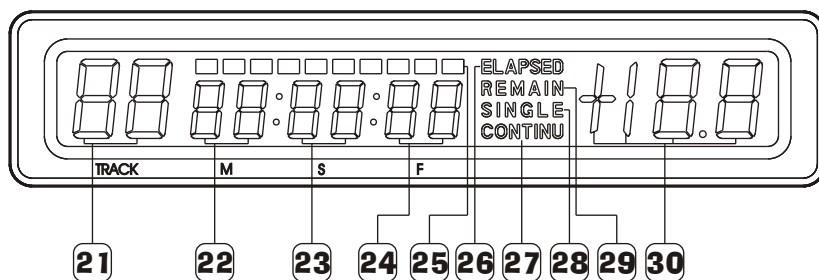

- | |
|------------------------------------------------------|
| (21) ~ (24) TRACK, MINUTE, SECOND and FRAME Displays |
| (25) BAR Indicator |
| (26) ELAPSED Indicator |
| (27) CONTINU Indicator |
| (28) SINGLE Indicator |
| (29) REMAIN Indicator |
| (30) PITCH DISPLAY |

PREPARATIONS

1. Checking the Contents

Check that the carton contains the following items:

- 1) Main unit
- 2) Control unit
- 3) Operating instructions (this booklet)
- 4) Pair of RCA pin cord.
- 5) Control cords (1 meter)

2. Installing the Unit

Mount the unit onto your console or rack with 19" EIA rack rails.

CAUTION:

- The player will work normally when the main unit is mounted with the front panel at within 15 degrees of the vertical plane. If the unit is tilted excessively, discs may not be loaded or unloaded properly. (Figure 1)
- The control panel's LCDs are designed to be clearly visible within the angles shown in Figure 2. Mount the control unit so that the visual angle is within this range.

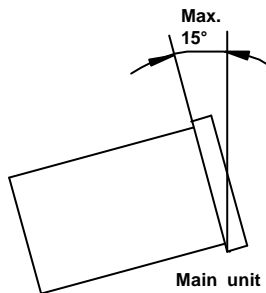

Figure 1

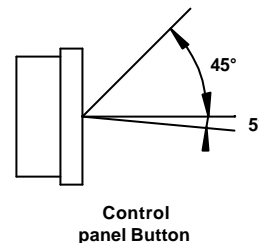

Figure 2

Connections

- 1) Turn off the POWER switch.
- 2) Connect the RCA pin cord to the input on your mixer.
- 3) Connect the control cords to the REMOTE connector on the main unit.

CAUTION:





- Be sure to use the supplied control cords. Using another type of cable may result in damage.
- Be sure the power is off when connecting the control cords. Otherwise the units may not work properly.

NAMES AND FUNCTIONS

Main Unit Front Panel

- (1) POWER  (Power ON/OFF Switch)
When the POWER switch is pressed, the power turns on.
- (2) Disc Holder
Place the discs in the holder. Press the OPEN/CLOSE button to open and close the disc holder.
- (3) OP/CL
Press it to open and close the disc holder. The control unit also includes OP/CL button. The disc holder cannot be opened during playback, so stop playback before pressing the button.
- (4) REMOTE CONTROL CONNECTOR
Connect this connector to the control unit using the included control cord.
- (5) AUDIO OUT
The audio signals from each player are output from these jacks.
- (6) DIGITAL OUT SOCKET
The music-signal of this socket is digital. Connect the output to the respective input of a digital amplifier for example.

CONTROL UNIT

- (1) OP/CL
Press it to open and close the disc holder. The main unit also includes OP/CL buttons. The disc holder cannot be opened during playback, so stop playback before pressing the button.
- (2) TIME (Time Button)
Press this button to switch the time display between the elapsed time and remaining time and total remain time.
The selected mode is indicated by the ELAPSED and REMAIN and TOTAL REMAIN indicator on the LCD.
- (3) LCD
- (4) LOOP (Loop Button)
Press the LOOP button to set the loop start point, press the LOOP button again to set the loop end point.
- (5) PITCH - Button
The CD slows down while this button is pressed. Release the button to return to the original BPM.
- (6) PITCH + Button
The CD speeds up while this button is pressed. Release the button to return to the original BPM.
- (7) PITCH (Pitch Button)
Use these button to enable or disable BPM adjustment with the pitch sliders. BPM adjustment with the pitch sliders is enabled when the PITCH LED lights.
- (8) Pitch Slider
Use the slider to adjust the CD pitch. Slide up to decrease the pitch, down to increase the pitch.
- (9) PLAY/PAUSE Button
Use the button to start playback. Press once to start playback, once again to set the pause mode, and once more to resume playback.
- (10) SGL/CTN (Single/Continuous Button)
Press it to switch between the single and continuous play modes. The SINGLE mode is indicated by the SINGLE indicator on the LCD.
- (11) CUE (Cue Button)
Press the CUE button during playback to return to the position at which playback started.
- (12) PROG.
Press the PROGRAM button, the player will enter the program mode and stop the CD playback.
- (13) B. SKIP 
Use these button to go back to the beginning of the current track or select a previous track for playing.
- (14),(15) SEARCH/SCAN  
Press these buttons to perform frame search function during pause mode or to perform scan function during play mode.
- (16) F. SKIP 
Use these button to skip to the next CD track.
- (17) PITCH (Pitch Indicator)
Moving the pitch slider will change the pitch only when the pitch LED is illuminated.
- (18) REALY
By pressing the RELAY button, the playback automatically switches to the other player after every track.
- (19) Control connector
Connect this connector to the REMOTE connector on the main unit using the included control cord.
- (20) Control socket
Via the Control socket, the respective CD-player can be remotely controlled. If you are using a mixer with fader start-function connect the player with the Control Out-socket. Please note that these sockets must never be connected with any voltage.

LCD

- (21) ~ (24) TRACK, MINUTE, SECOND and FRAME Displays
These displays indicate information for the CD's current position and time.
- (25) BAR Indicator
These ten indicators provide a visual display of the approximate position of the pickup within the current track.
- (26) ELAPSED Indicator
It indicates that the time shown for the display is the elapsed time.
- (27) CONTINU Indicator
When the indicator lights, the function will cause the unit to play continuously.
- (28) SINGLE Indicator
When the indicator lights, playback will stop at the beginning of the next track.
- (29) REMAIN Indicator
It indicates that the time shown on the display is the remaining time of playing track.
- (30) PITCH DISPLAY
It shows the BPM change range, the BPM changes within a range of +/-12%.

OPERATIONS

1. Opening and Closing the Disc Holder

- Turn the unit power on. Press the OPEN/CLOSE button to open the disc holder. OPEN/CLOSE buttons are provided on both the main unit and control unit.
- The disc holder cannot be opened during playback to prevent playback from being interrupted if the OPEN/CLOSE button is pressed accidentally. Stop the playback first, then press the OPEN/CLOSE button.

2. Loading discs

- Hold the disc by the edges and place it in the disc holder, then press the OPEN/CLOSE button again to close the disc holder. The unit will show the total track number and the total playing time for about 2 seconds then enter the cue condition, the cue point will be set to the music starting point of the first track automatically.

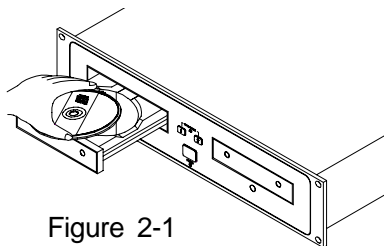

Figure 2-1

CAUTION:

- Do not place any foreign objects in the disc holder, and do not place more than one disc in the disc holder at a time.
- Do not push the disc holder in manually when the power is off, as this may result in malfunction and damage the player.

3. Selecting Tracks

- Press the SKIP button once to move to one higher or lower track.
- Hold the SKIP button to change tracks continuously at a higher speed.
- When a new track is selected during playback, playback begins as soon as the skip search operation is completed.
- If the skip **▶▶** button is pressed while at the last track, the first track is selected. In the same way, if the skip **◀◀** button is pressed while at the first track, the last track is selected.

4. Starting Playback

- Press the PLAY/PAUSE button during the pause or cue condition to start playback, the PLAY indicator lights.
- The point at which playback starts is automatically stored in the memory as the cue point. The pickup then returns to the cue point when the CUE button is pressed. (Back Cue)

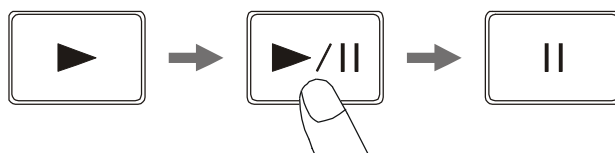

Figure 4-1

5. Stopping Playback

- There are two ways to stop playback.
 - 1). Press the PLAY/PAUSE button during playback to pause at that point.
 - 2). Press the CUE button during playback to return to the cue point and enter pause condition. (Back Cue)

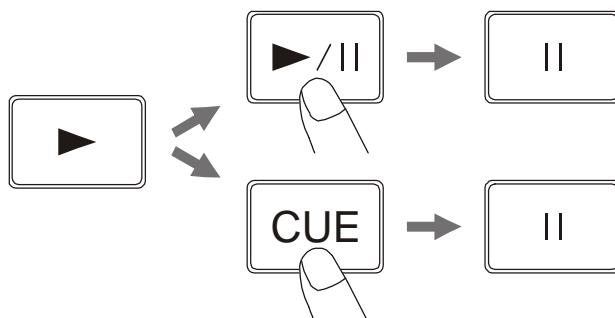

Figure 5-1

OPERATIONS

6. Pausing

- Press the PLAY/PAUSE button to switch between the play and pause.
- The pause indicator lights when the pause mode is set.
- Figure 6-1 show the relationship between the play and pause.

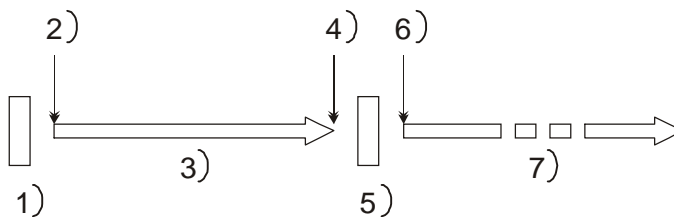

Figure 6-1

- 1) The player has completed the cue or pause operation and is waiting for the play start command.
- 2) When the PLAY/PAUSE button is pressed, playback starts and the cue point is stored in the memory.
- 3) Playing.
- 4) The pause mode is set when the PLAY/PAUSE button is pressed again
- 5) Pausing.
- 6) Playback resumes when the PLAY/PAUSE button is pressed again.
- 7) Playing.

7. Cueing

- "Cueing" is the action of preparing for playback.
- Press CUE button, the player will enter cue mode, the playback returns to cue point and enter pause condition, the cue and pause indicator light up. When PLAY/PAUSE button is pressed, play starts from the cue point.
- When the track search operation is completed after pressing the SKIP buttons, the player automatically finds the position at which the sound starts and cues there(Auto Cue).
- If the CUE button is pressed after the search operation or the scanning operation, the playback return to cue point and enter pause condition.
- Figure 7-1 shows the relationship between the play and back cue operations.

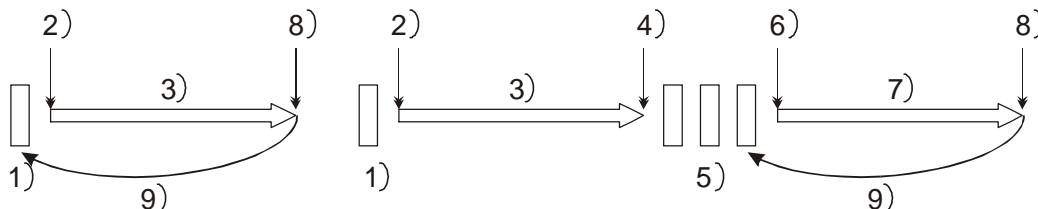

Figure 7-1

- 1) The player has completed the cue or pause operation and is waiting for the play start command.
- 2) When the PLAY/PAUSE button is pressed, playback starts and the cue point is stored in the memory.
- 3) Playing.
- 4) The pause mode is set when the PLAY/PAUSE button is pressed again.
- 5) Pausing.
- 6) When the PLAY/PAUSE button is pressed again, playback resumes and the new cue point is stored in the memory.
- 7) Playing.
- 8) Press the CUE button.
- 9) The pickup returns to the cue point.(Back Cue)

- Cue point setting:

When play starts from pause or skip to a new track by using skip button, the begin play point will be set to the new cue point.

When a new cue point is set, the cue indicator lights by flash for about 1 second.

NOTE: During cue mode, if the CUE button is pressed and hold, playback will start from the cue point, when the button is released, the player will return to the cue mode automatically, it allows you to check the cue point.

OPERATIONS

12. Program play

- ➊ Press the PROGRAM button, the player will enter the program mode and the CD will stop rotating.
- ➋ Select the desired track by pressing the SKIP button, then press the PROGRAM button again. The selected track will be added to the program sequence.
- ➌ Repeat step 2 operation. A maximum of 20 tracks can be programmed at one time.
- ➍ Press the PLAY/PAUSE button to start the program play from the first selection.
- ➎ Press the program button again during program play to stop play.
- ➏ Press and hold the program button more than 2 seconds to cancel the program mode and erase all the current program contents.

13. Loop Play

- ➊ Press the LOOP button to set the loop start point A, the LOOP indicator will flash on the LCD.
- ➋ Press the LOOP button again to set the loop end point B, after the B point is set, the playback will enter the loop play from A to B repeatedly.
- ➌ Press the LOOP button again, the loop play function is canceled, the LOOP indicator goes out.

14. Faderstart

With the S-500, you have the possibility to start the respective CD-player directly from the mixer. Make sure that the Control socket is connected with the respective socket on the mixer. Additionally, the Audio out socket has to be connected with the Line-input sockets of your mixer. Please note that the Faderstart function only works with the appropriate mixers. Insert the CD and select the desired track. Start playback from your mixer.

15. Relay

In the Relay-operation, the device automatically switches to the other player after every track. In this way, you have the possibility to enlarge the music program by using several CDs.

Possibility 1:

Connect the Control-sockets of the two CD-players with one another. The Relay-button must remain unpressed (LED off). Press the Single-button (The display shows "SINGLE") on both CD-players. Start playback of CD1. As soon as the current track of CD1 is finished, the player automatically starts CD2. The first CD-player goes into Pause-mode. You can enter a new CD or memorize a Cue-point at the respective player in the Pause-Mode.

CAUTION: The Relay-operation does not work properly if the two CD-players are connected to different power amplifiers.

Possibility 2:

Press the Relay-button (LED on).

In the Single-mode, the device automatically starts with the playback of the other CD-player of the other CD-player at the end of the track.

During the Relay-operation, the Faderstart-function is disabled.

You can switch the Relay-operation off via the Relay-button (LED on) and the Faderstart-function will work again.

BEFORE SWITCHING OFF THE POWER

When you have finished using the CD player, before switching off the power, be sure that the disc holder had been closed with the OPEN/CLOSE button.

CAUTION:

Do not forcibly close the disc holder when the power is off.

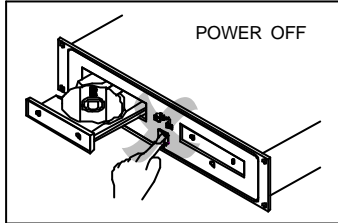

Do not switch off the power when the disc holder is open.

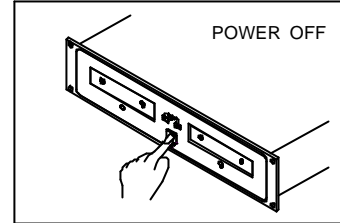

Switch off the power after the disc holder has been closed with the OPEN/CLOSE button.

COMPACT DISCS

1. Precautions on handling compact discs

- Do not allow fingerprints, oil or dust to get on the surface of the disc.
If the disc is dirty, wipe it off with a soft dry cloth.
- Do not use benzene, thinner, water, record spray, electrostatic-proof chemicals, or silicone-treated cloths to clean discs.
- Always handle discs carefully to prevent damaging the surface; in particular when removing a disc from its case or returning it.
- Do not bend the disc.
- Do not apply heat.
- Do not enlarge the hole in the center of the disc.
- Do not write on the label (printed side) with a hard-tipped implement such as a pencil or ball point pen.

- Condensation will form if a disc is brought into a warm area from a colder one, such as outdoors in winter. Do not attempt to dry the disc with a hair dryer, etc.

2. Precaution on storage

- After playing a disc, always unload it from the player.
- Always store the disc in the jewel case protect from dirt or damage.
- Do not place discs in the following areas:
 - ① Areas exposed to direct sunlight for a considerable time.
 - ② Areas subject to accumulation of dust or high humidity.
 - ③ Areas affected by heat from indoor heaters, etc.

SPECIFICATIONS

GENERAL

Dimensions:	Main unit:	482(W) x 88.8(H) x 262(D) mm
	Control unit:	482(W) x 88.8(H) x 80(D) mm
Weight:	Player unit:	5 kgs
	Control unit:	2 kgs
Power supply:	115 / 230V AC, 50 / 60Hz	
Power consumption:	25W	